

BOLERO

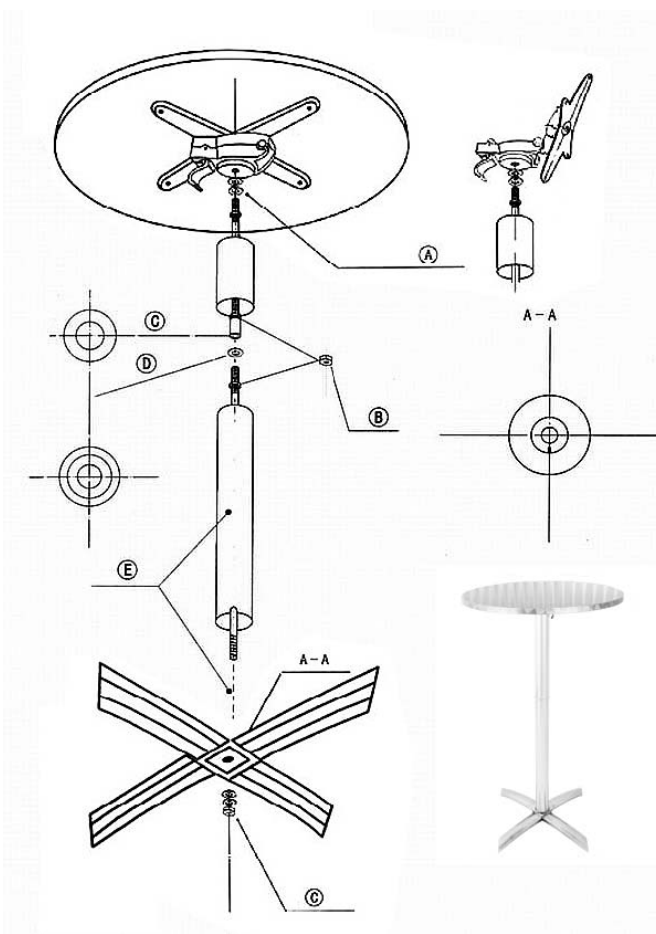





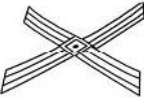

Code GR396 :- Bolero Flip Top Poseur Table St/St - 60cm dia

- (UK) Telephone Helpline: 0845 146 2887 (United Kingdom) / 1300 225960 (Australia)
(NL) Klantenondersteuning: 040 – 2628080 (Nederland) / 050 – 609999 (België)
(FR) Standard d'assistance téléphonique: 01 64 89 73 61 (Français) / 050 – 600006 (Belgique)
(DE) Telefonische Helpline: 0800 – 1860806 (Deutschland)
(ES) Línea de asistencia telefónica : 901-100 133 (España)

Assembly Instructions:-



Parts list:

	1 x Table Top
	1 x Table Base
	3 x Spring
	3 x Washer
	3 x Nut
	2 x Aluminium tube
	1 x Spanner
	1 x Socket spanner
	1 x pole join

Assembly instructions:

1. Thread a nut onto one threaded end of the threaded bar
2. Place a washer over the hole on the metal spider on the underside of the table, and insert the threaded end of the bar
3. Turn the threaded bar until it securely grips into the metal spider on the underside of the table (do not tighten so much that the bar presses against the underside of the table itself)
4. Tighten the nut back down onto the unit using the spanner supplied
5. Place the aluminium tube over the threaded bar, ensuring that the end of the tube is securely positioned on the metal spider (see detail A)
6. Place the aluminium base over the end of the threaded bar (see detail B), ensuring the notch at the bottom of the tube lines up with the lug on the table base (as shown in detail A-A)
7. Place the base weight over the end of the threaded bar
8. Place a washer and nut on the end of the threaded bar (see detail C) and tighten using the socket spanner
9. Finally screw the feet to the Table base